



5300 Beethoven Street, Los Angeles, CA 90066
 TEL: (310)306-5556 • FAX: (310)821-7413
 WEB: www.ophirrf.com • E-MAIL: sales@ophirrf.com

Broadband High Power TWT RF Amplifier

The Ophir RF Model 6535, CW TWT Amplifier has been designed to operate at 250 watts from 7.5-18.0 GHz.

Internal power supplies are solid state DC-DC converter designs with fast loop response times so that output level variations are minimal.

Both cathode and collector power supplies and the heater supply are duty cycle regulated designs.

The cathode and collector power supplies have very low ripple, with attendant low phase noise in the TWT Amplifier. Output spurious signals are less than -50 dBc.

Plug-in PC boards are accessible through the front panel.

The PC card cover contains a legend for PC card located test points and controls.

The modular design of the Model 6535 provides convenient accessibility to all elements in the TWT amplifier. High voltage modules are encapsulated, plug-in assemblies.

There is no exposed high voltage. Most modules are interchangeable between all TWT units regardless of frequency.



MODEL 6535

7.5-18.0 GHz
250 WATTS
TWT POWER RF AMPLIFIER

MODEL 6535 FEATURES

- ◇ - Low Spurious Outputs
- ◇ - Phase and Amplitude Stability
- ◇ - Complete TWT Protection
 - Helix Overcurrent
 - Cathode Over/Undervoltage
 - Collector Overvoltage
 - Filament Low Voltage
 - Over temperature
 - Input Energy Limit
 - Reverse Power Monitor
- ◇ - Custom Requirements
- ◇ - Solid State Except for the TWT
- ◇ - Front Panel Voltage Adjustments
- ◇ - Front Panel Fault Isolation
- ◇ - Modular Construction
- ◇ - DC TWT Filaments
- ◇ - Four Line Display
 - Operating Mode
 - Cathode Voltage
 - Collector Voltage(s)
 - Helix Current
 - Filament and Operate Time
- ◇ - Front Panel Controls
 - Power On / Off
 - Operate
 - Standby
 - Fault Reset
 - Local / Remote

Specifications subject to change without notice

STANDARD ONE YEAR WARRANTY





5300 Beethoven Street, Los Angeles, CA 90066
 TEL: (310)306-5556 • FAX: (310)821-7413
 WEB: www.ophirrf.com • E-MAIL: sales@ophirrf.com

MODEL 6535
7.5-18.0 GHz
250 WATTS
TWT POWER RF AMPLIFIER

	<u>Parameter</u>	<u>Specification @ 25° C</u>
1	Frequency Range	7.5-18.0 GHz
2	Saturated Output Power	250 Watts Typical
3	Duty Cycle	CW
4	Phase Noise	Less than +/- 1°
5	Amplitude Variation	0.1 dB Maximum
6	Gain	35 dB Minimum
7	Noise Figure	35 dB Nominal
8	RF Connectors	Type N or Waveguide
9	Primary Power	3Ø Phase, 208VAC +/- 10% 50/60 Hz
10	Operating Temperature	0° to 50° C
11	Weight	140 lbs Nominal
12	Dimensions (H x W x D)	12.25" x 19" x 28.5"

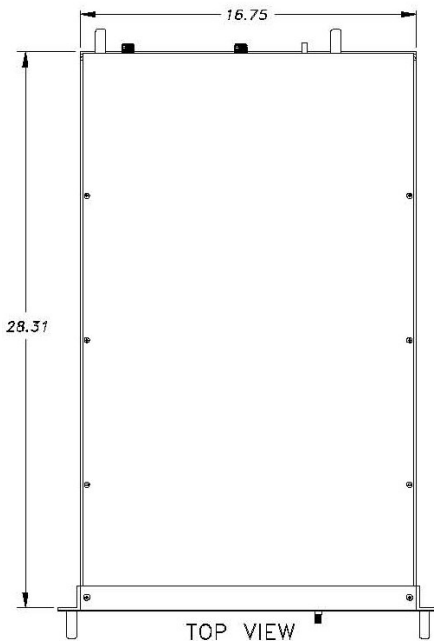
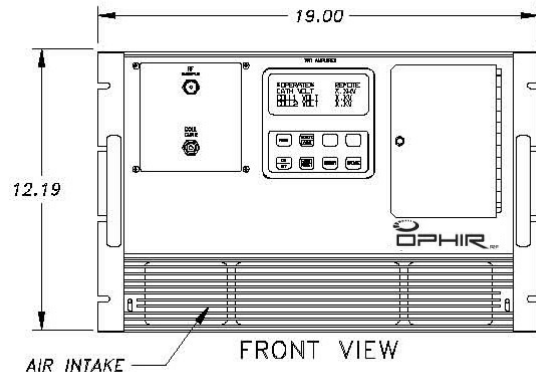
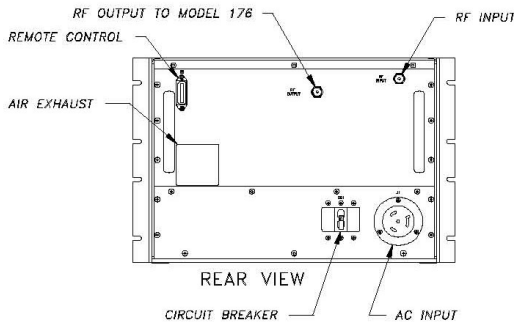

STANDARD FEATURES

- ◇ - Input Isolator
- ◇ - Filament/ Operate Time
- ◇ - IEEE-488 Remote Interface
- ◇ - Reverse Power Monitor

OPTIONAL FEATURES

- ◇ - Driver Amplifier
- ◇ - Higher CW Power
- ◇ - Extended Frequency Coverage
- ◇ - RF Sample Ports
- ◇ - RS-232/422 Remote Interface
- ◇ - Other Primary Power
- ◇ - Outdoor Enclosure
- ◇ - RF Connectors on Front Panel
- ◇ - Harmonic Filters